



Surface Mount TRANSZORB[®] Transient Voltage Suppressors



DO-214AA (SMBJ)

PRIMARY CHARACTERISTICS	
V_{WM}	3.3 V
P_{PPM}	600 W
I_{FSM}	60 A
T_J max.	175 °C

FEATURES

- Uni-directional polarity only
- Peak pulse power: 600 W (10/1000 μ s)
- Excellent clamping capability
- Very fast response time
- Meets MSL level 1, per J-STD-020, LF maximum peak of 260 °C
- Compliant to RoHS Directive 2002/95/EC and in accordance to WEEE 2002/96/EC
- Halogen-free according to IEC 61249-2-21 definition



RoHS
COMPLIANT
HALOGEN
FREE

TYPICAL APPLICATIONS

Use in sensitive electronics protection against voltage transients induced by inductive load switching and lighting on ICs, MOSFET, signal lines of sensor units specifically for protecting 3.3 V supplied sensitive equipment against transient overvoltages.

MECHANICAL DATA

Case: DO-214AA (SMBJ)

Molding compound meets UL 94 V-0 flammability rating
Base P/N-M3 - halogen-free, RoHS compliant, and commercial grade

Terminals: Matte tin plated leads, solderable per J-STD-002 and JESD22-B102

M3 suffix meets JESD 201 class 1A whisker test

Polarity: Color band denotes cathode end

MAXIMUM RATINGS ($T_A = 25$ °C, unless otherwise noted)			
PARAMETER	SYMBOL	VALUE	UNIT
Peak pulse power dissipation	$P_{PPM}^{(1)(2)}$	600	W
Peak pulse current with a 10/1000 μ s waveform (fig. 1)	I_{PP}	50	A
Peak pulse current with a 8/20 μ s waveform (fig. 1)	I_{PPM}	200	A
Non-repetitive peak forward surge current 8.3 ms single half sine-wave	$I_{FSM}^{(2)}$	60	A
Power dissipation on infinite heatsink, $T_L = 75$ °C	P_D	5	W
Operating junction and storage temperature range	T_J, T_{STG}	- 65 to + 175	°C

Notes

(1) Non-repetitive current pulse, per fig. 1

(2) Mounted on 0.2" x 0.2" (5.0 mm x 5.0 mm) copper pads to each terminal

ELECTRICAL CHARACTERISTICS ($T_A = 25$ °C unless otherwise noted)											
DEVICE TYPE	DEVICE MARKING CODE	BREAKDOWN VOLTAGE V_{BR} AT I_T MIN.		MAXIMUM REVERSE LEAKAGE CURRENT I_R AT V_{WM} MAX.		MAXIMUM CLAMPING VOLTAGE V_C AT I_{PP} 10/1000 μ s		MAXIMUM CLAMPING VOLTAGE V_C AT I_{PPM} 8/20 μ s		TYPICAL TEMP. COEFFICIENT OF V_{BR} (10^{-4} /°C)	TYPICAL JUNCTION CAPACITANCE C_J AT 0 V 1 MHz
		V	mA	μ A	V	V	A	V	A		
SMBJ3V3	KC	4.1	1.0	200	3.3	7.3	50	10.3	200	- 5.3	5200



THERMAL CHARACTERISTICS ($T_A = 25\text{ }^\circ\text{C}$ unless otherwise noted)			
PARAMETER	SYMBOL	VALUE	UNIT
Typical thermal resistance, junction to lead	$R_{\theta JL}$ (1)	20	$^\circ\text{C/W}$
Typical thermal resistance, junction to ambient	$R_{\theta JA}$ (2)	100	$^\circ\text{C/W}$

Note

- (1) Thermal resistance from junction to lead - mounted on 0.2" x 0.2" (5.0 mm x 5.0 mm) copper pads to each terminal
- (2) Thermal resistance from junction to ambient - mounted on the recommended PCB pad layout

ORDERING INFORMATION (Example)				
PREFERRED P/N	UNIT WEIGHT (g)	PREFERRED PACKAGE CODE	BASE QUANTITY	DELIVERY MODE
SMBJ3V3-M3/52	0.096	52	750	7" diameter plastic tape and reel
SMBJ3V3-M3/5B	0.096	5B	3200	13" diameter plastic tape and reel

RATINGS AND CHARACTERISTICS CURVES

($T_A = 25\text{ }^\circ\text{C}$ unless otherwise noted)

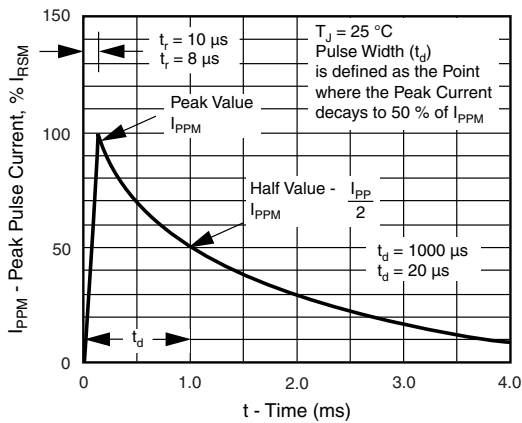

Fig. 1 - Pulse Waveform

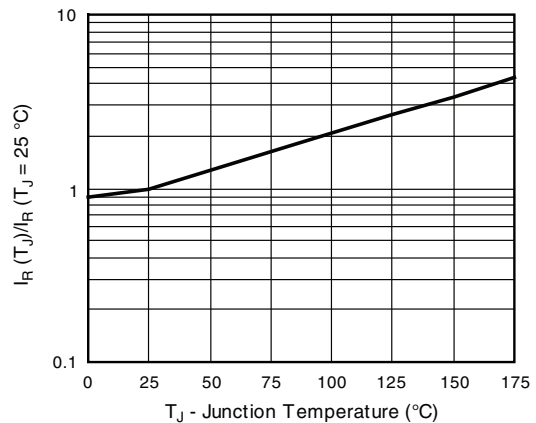

Fig. 3 - Relative Variation of Leakage Current vs. Junction Temperature

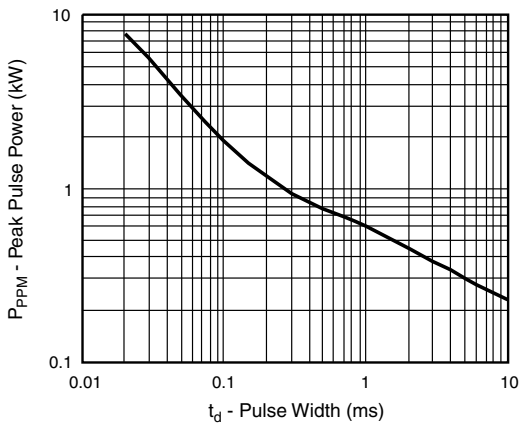

Fig. 2 - Peak Pulse Power Rating Curve

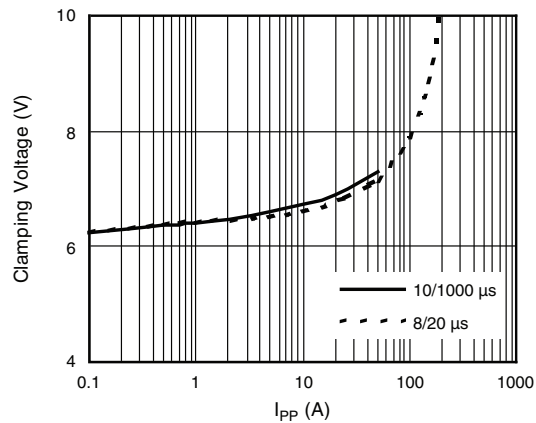

Fig. 4 - Clamping Voltage vs. Peak Pulse Current (T_J initial = $25\text{ }^\circ\text{C}$)

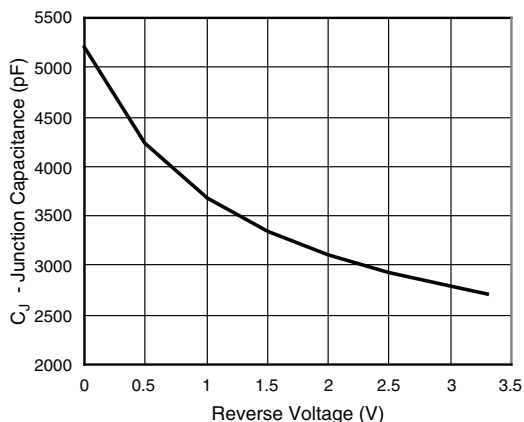

Fig. 5 - Typical Junction Capacitance

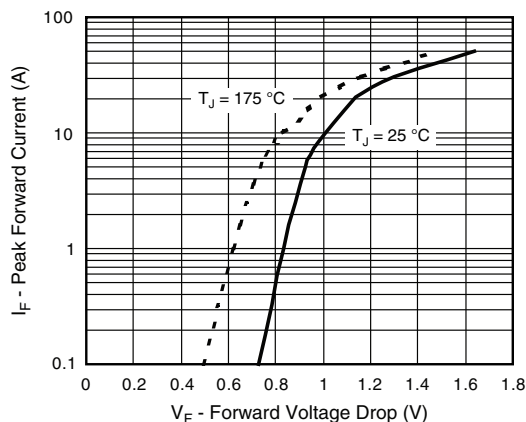

Fig. 7 - Typical Peak Forward Voltage Drop vs. Peak Forward Current

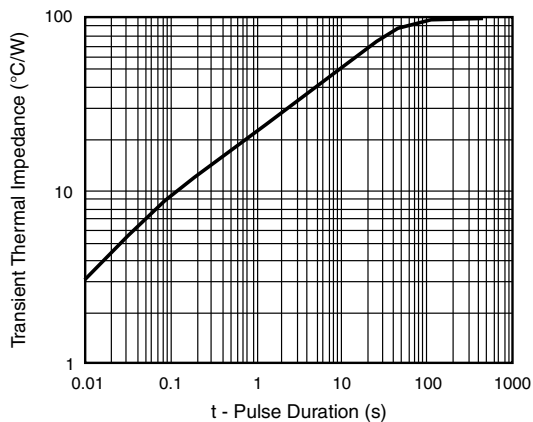
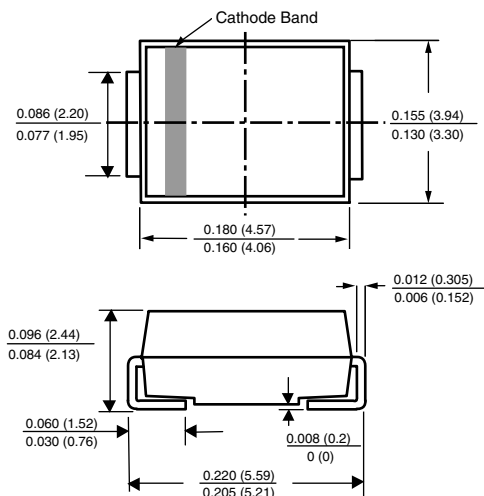

Fig. 6 - Typical Transient Thermal Impedance

PACKAGE OUTLINE DIMENSIONS in inches (millimeters)

DO-214AA (SMB-J-Bend)



Mounting Pad Layout

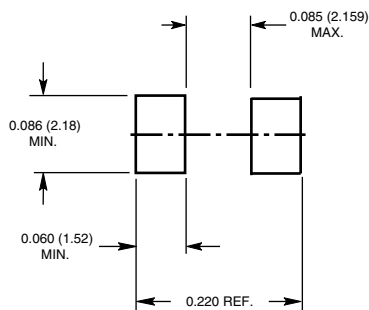



Disclaimer

ALL PRODUCT, PRODUCT SPECIFICATIONS AND DATA ARE SUBJECT TO CHANGE WITHOUT NOTICE TO IMPROVE RELIABILITY, FUNCTION OR DESIGN OR OTHERWISE.

Vishay Intertechnology, Inc., its affiliates, agents, and employees, and all persons acting on its or their behalf (collectively, "Vishay"), disclaim any and all liability for any errors, inaccuracies or incompleteness contained in any datasheet or in any other disclosure relating to any product.

Vishay makes no warranty, representation or guarantee regarding the suitability of the products for any particular purpose or the continuing production of any product. To the maximum extent permitted by applicable law, Vishay disclaims (i) any and all liability arising out of the application or use of any product, (ii) any and all liability, including without limitation special, consequential or incidental damages, and (iii) any and all implied warranties, including warranties of fitness for particular purpose, non-infringement and merchantability.

Statements regarding the suitability of products for certain types of applications are based on Vishay's knowledge of typical requirements that are often placed on Vishay products in generic applications. Such statements are not binding statements about the suitability of products for a particular application. It is the customer's responsibility to validate that a particular product with the properties described in the product specification is suitable for use in a particular application. Parameters provided in datasheets and/or specifications may vary in different applications and performance may vary over time. All operating parameters, including typical parameters, must be validated for each customer application by the customer's technical experts. Product specifications do not expand or otherwise modify Vishay's terms and conditions of purchase, including but not limited to the warranty expressed therein.

Except as expressly indicated in writing, Vishay products are not designed for use in medical, life-saving, or life-sustaining applications or for any other application in which the failure of the Vishay product could result in personal injury or death. Customers using or selling Vishay products not expressly indicated for use in such applications do so at their own risk and agree to fully indemnify and hold Vishay and its distributors harmless from and against any and all claims, liabilities, expenses and damages arising or resulting in connection with such use or sale, including attorneys fees, even if such claim alleges that Vishay or its distributor was negligent regarding the design or manufacture of the part. Please contact authorized Vishay personnel to obtain written terms and conditions regarding products designed for such applications.

No license, express or implied, by estoppel or otherwise, to any intellectual property rights is granted by this document or by any conduct of Vishay. Product names and markings noted herein may be trademarks of their respective owners.

Material Category Policy

Vishay Intertechnology, Inc. hereby certifies that all its products that are identified as RoHS-Compliant fulfill the definitions and restrictions defined under Directive 2011/65/EU of The European Parliament and of the Council of June 8, 2011 on the restriction of the use of certain hazardous substances in electrical and electronic equipment (EEE) - recast, unless otherwise specified as non-compliant.

Please note that some Vishay documentation may still make reference to RoHS Directive 2002/95/EC. We confirm that all the products identified as being compliant to Directive 2002/95/EC conform to Directive 2011/65/EU.